

ISOMAX CLIP SYSTEM

Wall or ceiling

Technical Data Sheet

PRODUCT DESCRIPTION

The IsoMax Clip is a high performing sound reduction system designed to completely isolate walls and ceilings.

Attaching the IsoMax Clip to ceiling joists, timber and metal studs or masonry simply and easily secures the drywall furring channel, and decouples the gypsum board from the nonisolated structure. The resulting construction provides a resilient isolation solution for internal walls and ceilings.

FEATURES and BENEFITS

- Offers a robust and higher performing alternative to traditional wall and ceiling isolation methods
- Outperforms standard resilient bar construction by up to 7dB*
- Withstands greater loads than standard systems to provide peace of mind for developers and dwellers
- Reduces the risk of error at installation stage, as screws cannot be inadvertently attached to the stud or joist through the resilient area
- Works as a space saving solution for either existing or new wall constructions, with minimal encroachment into living space
- For situations where fire protection is a consideration, fire rated wall and ceiling systems are also available
- Offers one of the most cost effective methods available to achieve superior noise control in walls and ceilings while using standard materials

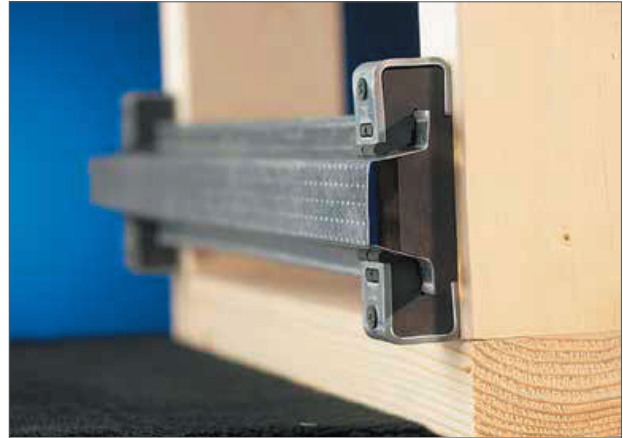

GENERAL INFORMATION

All potential sound leaks; gaps around outlets, window, or door frames; pipe penetrations and the like should be sealed with a non-hardening acoustical sealant.

The IsoMax Clip system is available in the UK and Ireland exclusively from CMS Danskin Acoustics as the result of a joint venture between UK based CMS Danskin Acoustics and Kinetics® Noise Control, one of the world leaders in noise control.

For information on other Kinetics® architectural and antivibration products available from CMS Danskin Acoustics, please contact your local branch.

LOAD SPECIFICATION FOR ISOMAX CLIP SYSTEM

The IsoMax Clip is designed to carry a drywall furring channel with one or more layers of gypsum wallboard attached.

The maximum design load capacity for the IsoMax Clip in shear (wall application) or in tension (ceiling application) is as follows.

Design load calculations are based on tested loading to failure where the furring channel deforms and pulls out.

Design Load Maximum for Wall or Ceiling Application
22kgs per IsoMax Clip.

INSTALLATION OF ISOMAX CLIP SYSTEM - WALLS AND CEILINGS

- Spacing of IsoMax Clips on the furring channel shall be a maximum of 1200mm
- Spacing between furring channels shall be a maximum of 600mm
- Use only CMS Danskin Acoustics furring channel
- (Walls only) The first layer of gypsum wallboard shall align seams between sheets on the centerline of the horizontal furring channels
- (Walls only) The bottom row of IsoMax Clips with furring channel(s) should be a maximum 76mm to the center of the channel from the floor. The top row should be within 150mm of the ceiling
- (Walls only) The first row of gypsum wallboard sheets at the bottom of the wall shall be installed with the long dimension supported on 6mm thick continuous resilient isolation strip
- (Ceilings only) The IsoMax Clips should be within 150mm of the ceiling perimeter at the end of the furring channel run
- (Ceilings only) The first row of channel at the ceiling perimeter should be a maximum 150mm from the wall
- Furring channels are installed perpendicular to the framing members

STEP 1

Attach IsoMax Clips per CMS Danskin Acoustics layout guidelines for walls or ceilings. See attached layout drawings.

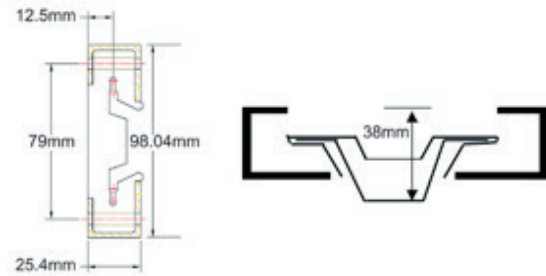

STEP 2

To affix the IsoMax Clips to the sub-wall/partition Secure IsoMax Clips with a single fastener on one end only.

Into timber use No. 8 dia screws x 65mm long.

Into steel use either No. 8, 10 or 12 self tapping screws 40mm long.

Into concrete or masonry use 4mm dia x 60mm long screws into matching Rawlplug/Fischer fixing system.

OPTIONAL

Alternate method for Step 2. Snap IsoMax Clips onto furring channel.

Hand slide IsoMax Clips to proper location on the furring channel.

Fasten both ends of the IsoMax Clip to secure the channel.

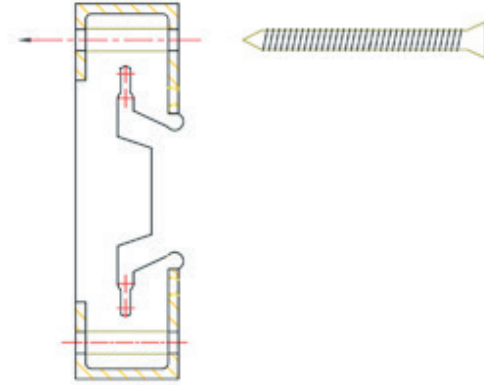

STEP 3

Grip unsecured rubber end, snap in channel. Secure with second screw/anchor.

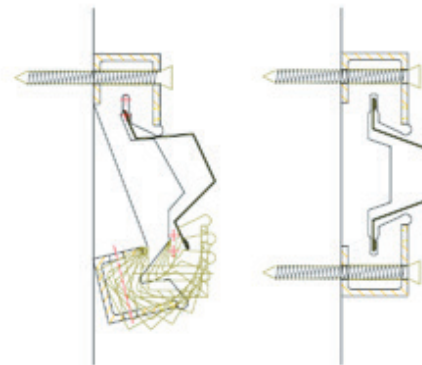

FURRING CHANNEL REQUIREMENTS

Min 0.5mm to Max 0.7mm galvanized steel.

Standard – 22.5mm deep channel.

Splice furring channel with a 150mm overlap and secure overlapped pieces with wire or screws per standard industry practice.

To affix the 12mm plasterboard/Soundblock board to the IsoMax channels.

For one layer use plasterboard screws suitable for self drilling into a metal stud system at 25mm in length.

When using two layers of plasterboard the first layer should be affixed using a 25mm long screw as above, the second layer should be affixed using 35mm long screw into the channel.

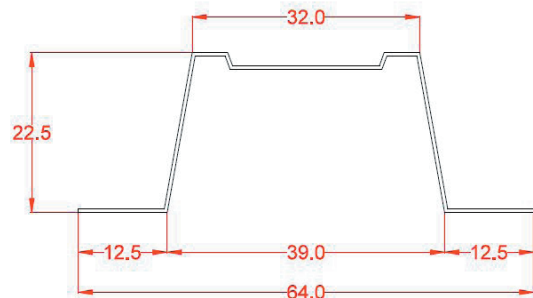

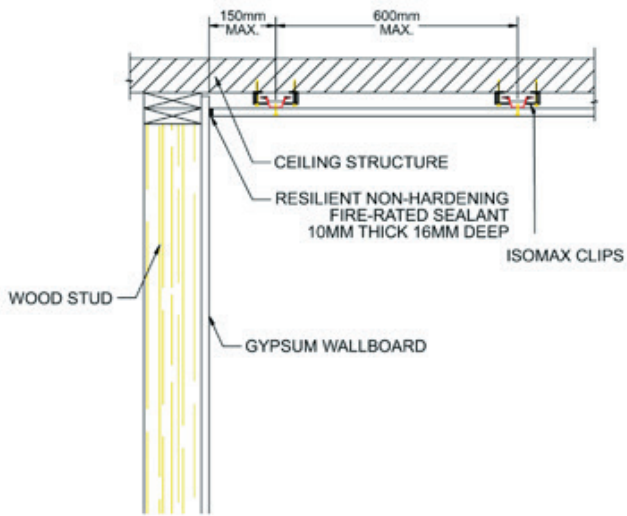

**RESILIENTLY MOUNTED CEILING
WITH DIRECT ATTACHED WALL**

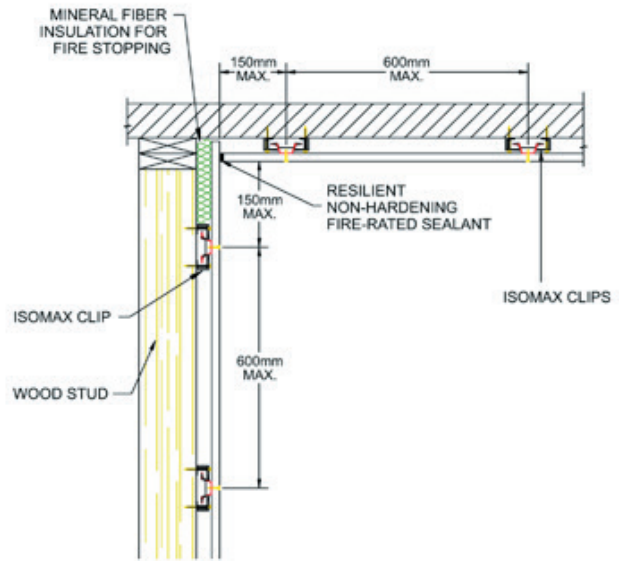

RESILIENTLY MOUNTED WALL & CEILING

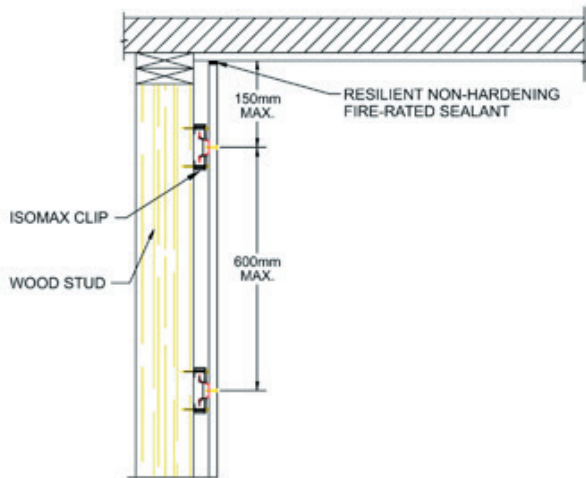

**RESILIENTLY MOUNTED WALL
WITH DIRECT ATTACHED CEILING**

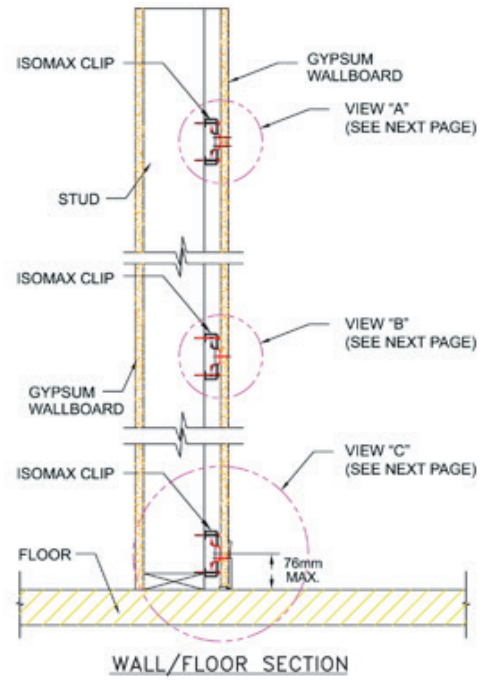

WALL/FLOOR SECTION

NOTE: FOR ACOUSTICAL ISOLATION
BASE BOARD OR ANY OTHER
WALL ATTACHMENTS MUST NOT
TOUCH THE FLOOR.

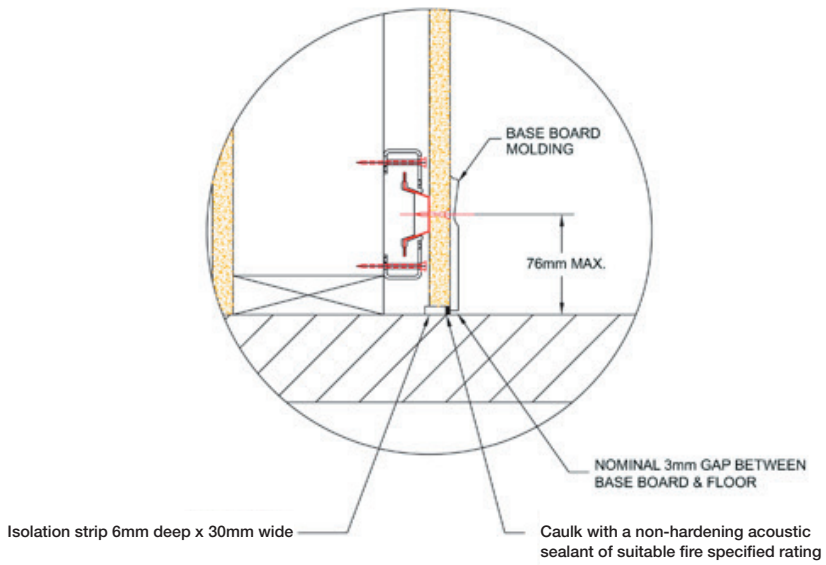

ENLARGED VIEW "C"

