



Regupol®

# TECHNICAL DATA SHEET

## REGUPOL® 7210C SCREED ISOLATION

### PRODUCT DESCRIPTION

Regupol® 7210C is a cost-effective rubber bound underscreed material specifically introduced for the PCT (Pre-Completion Test) market for the isolation of all screed types for compliance with Approved Document E Building Regulations (England & Wales) and Section H of the Scottish Building Regulations.

### APPLICATIONS

Regupol® 7210C is used under all types of floor screeds including:

- New build apartments
- Hotels
- Schools
- Care homes
- Commercial facilities

Recommended for all PCT (Pre-Completion Testing) sites.

### BENEFITS

- Has been independently tested on-site to show compliance in accordance with Approved Document E and section H of the Building Regulations.
- Excellent impact and airborne performance
- Offers long term performance without collapse or “bottoming” out under high point loads
- Minimal creep, even under high loads
- Resistant to ageing and deformation
- Quick and easy to install with no need for separate perimeter strips
- Minimises construction heights
- High quality and exact material thickness guaranteed
- Suitable for use with underfloor heating
- Protects expansion joints
- Zero ozone depletion potential (ODP), zero global warming potential (GWP)
- Mildew and moisture resistant
- When used with a sand/cement screed; there is no requirement to use a dpm (please see diagrams)
- Product manufactured using Recycled Materials and 100% recyclable



## PHYSICAL INFORMATION

Sheet length	2.25m
Sheet width	1.15m
Roll length	10m
Roll width	1.15m
Material thickness	5mm standard, 3mm available upon request

## TECHNICAL INFORMATION

Density	720kg/m <sup>3</sup>
Tensile strength (DIN 53571)	0.5N/mm <sup>2</sup>
Thermal conductivity	approx 0.14W/mK
Elongation at break	approx 75%
Temperature resistance	-40°C to +110°C
Airborne sound insulation (DnT,w + Ctr)	49dB (mean average)*
Impact sound insulation (L'nT,w (Ci))	- 3mm 50dB*** - 5mm 46dB (mean average)**
Impact performance ΔLW	- 3mm 18dB - 5mm 20dB

\* Building Regulations Approved Document E requirements 45dB or greater (performance figures obtained from independent testing)

\*\* Building Regulations Approved Document E requirements 62dB or less

\*\*\* Site Test 250mm slab, 3mm Regupol 7210C, 33mm screed, 20mm Marble NO Ceiling (performance figures obtained from independent testing)

## INSTALLATION SERVICE

In addition to supply of this product, CMS Danskin Acoustics offers a competitively-priced installation service anywhere in the UK. Use of our service ensures that installation is performed to the highest standards by tradesmen fully experienced in the specialist skills of fitting acoustic materials correctly.

Please contact your local CMS Danskin Acoustics for further details.

## REGUPOL® 7210C WITH DPM

(only applicable where proprietary free flowing screeds are used)

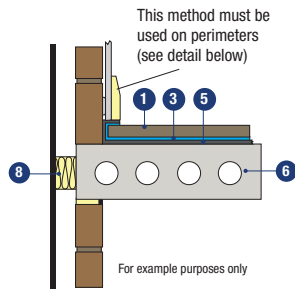
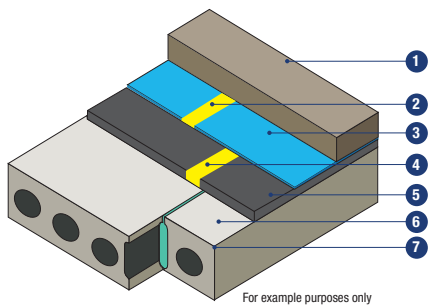

- 1 Min. 40mm proprietary screed nominal 80kg/m<sup>2</sup>
  - 2 Taped joint\*
  - 3 Min. 500 gauge polythene sheeting
  - 4 Joint detail
  - 5 Regupol® 7210C 3/5mm layer
  - 6 Pre-cast hollow core
  - 7 Perimeter detail
  - 8 Acoustic cavity closer
  - 9 Hi-tack tape
- \* DPM overlap to be minimum 100mm

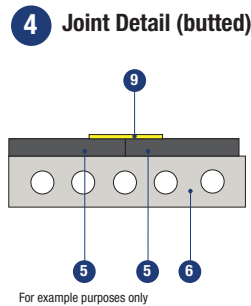
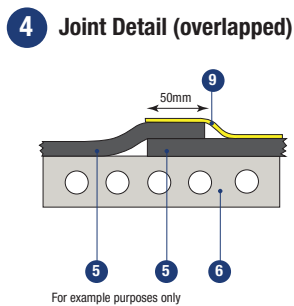
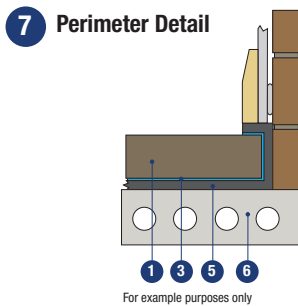

## REGUPOL® 7210C WITHOUT DPM

(for use with Sand/Cement Screeds only)

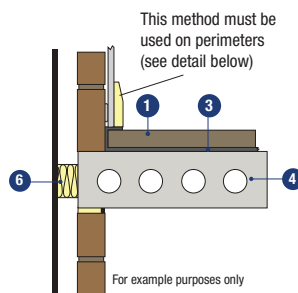
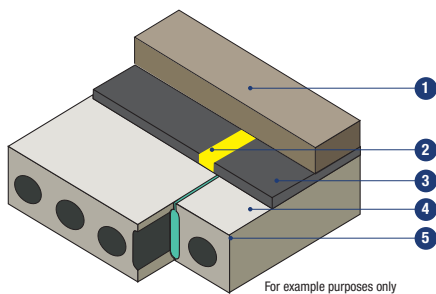

- 1 Min. 65mm sand cement screed
- 2 Joint detail
- 3 Regupol® 7210C 3/5mm layer
- 4 Pre-cast hollow core
- 5 Perimeter detail
- 6 Acoustic cavity closer
- 7 Hi-tack tape

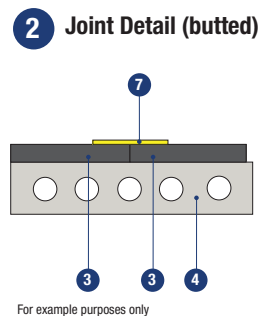
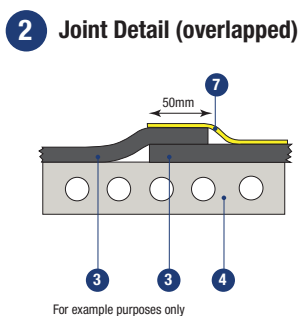
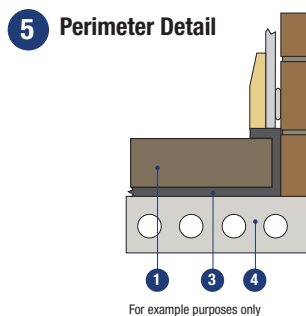

### CMS DANSKIN ACOUSTICS

**Scotland Office:** Tel: 01698 356000 Fax: 01698 372222  
1 Netherton Road, Wishaw, ML2 0EQ

**Central/Southern Office:** Tel: 01925 577711 Fax: 01925 577733  
Unit 2 Lyncastle Road, Appleton, Warrington, WA4 4SN

Email: [info@cmsdanskin.co.uk](mailto:info@cmsdanskin.co.uk) Website: [www.cmsdanskin.co.uk](http://www.cmsdanskin.co.uk)

**IMPORTANT:** Directions for use are given for guidance only and are not intended to form part of any contract. They should be varied or adapted to suit your particular materials or conditions of use. It is strongly recommended that prospective users test a sample of the product under their own conditions to satisfy themselves of its suitability for the intended purpose. For the Pre Completion Testing route to compliance with the Building Regulations CMS Danskin Acoustics may provide site test evidence (where available) concerning the use of their product in a similar overall construction. Test evidence of a product passing minimum standards in one construction is not a warranty or specification that the same product will meet the desired acoustic performance level in any other building. Such evidence can only be considered indicative and should not be relied upon.

**CMSDANSKIN**  
ACOUSTICS